

# Nord-Lock washers

Product information



# The proven original



Since the Nord-Lock Group began operations in 1982 we have focused on providing the world's most effective bolt securing systems. Our products are based on leading wedge-locking technology and are recognized for their ability to safely secure bolted joints exposed to severe vibration and dynamic loads.

When you choose Nord-Lock you do not only choose a supplier or a manufacturer, you also benefit from a partnership with an expert in bolted joint technology. Our global team of sales engineers work with our clients to solve bolt securing problems in the most demanding applications.

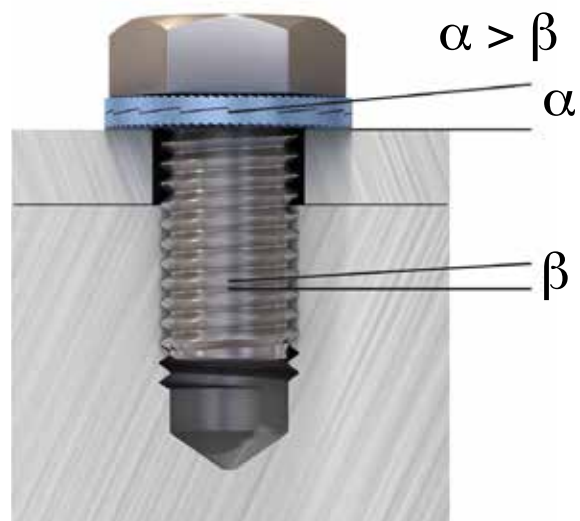

*Nord-Lock wedge-locking technology*



*Nord-Lock wedge-locking products are the optimum choice for critical bolted joints.*

Nord-Lock washers secure bolted joints with tension instead of friction. The system is comprised of a pair of washers that has cams on one side and radial teeth on the opposite side. Since the cam angle ' $\alpha$ ' is greater than the thread pitch ' $\beta$ ' a wedge effect is created by the cams, preventing the bolt from rotating loose.



Over the years, Nord-Lock washers have been rigorously tested and approved by independent institutes as well as certification authorities.

### Proven in Junker vibration test

The Junker test, according to DIN 65151, is considered the most severe vibration test for bolted connections. During the test, the joint is exposed to transverse movements underneath the bolt head / nut, while the clamping force is continuously measured.

### Vibration test

Bolt M8, grade 8.8, with clamp length 25 mm

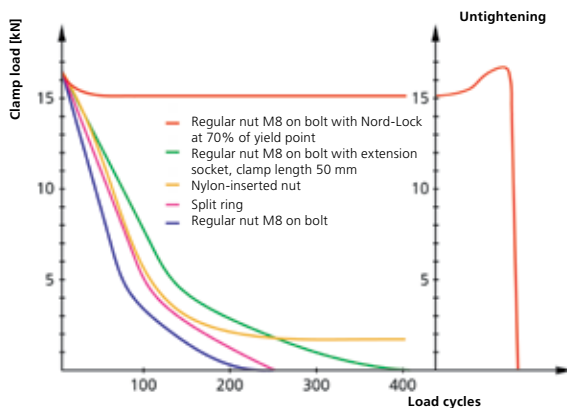

Fig 1: The Junker test shows that Nord-Lock washers safely secured the bolted connection; only a limited amount of tension is initially lost due to normal settlements. The wedge-locking function is verified through the clear increase in tension during untightening. All other bolt locking methods in the test failed to prevent loosening of the joint.

Nord-Lock washers are proven as a safe bolt securing system according to DIN 65151 tests performed by the independent research organizations IMA and CETIM. In addition, Nord-Lock personnel performs over 10,000 live Junker vibration tests around the globe every year. Would you like to see a live demonstration? Find your nearest representative through [www.nord-lock.com/contact](http://www.nord-lock.com/contact).

### Proven according to NASM impact & vibration test

The National Aerospace test, according to NASM 1312-7, is a test method originally developed by the U.S. military to test bolted connections' resilience against impact and vibration.

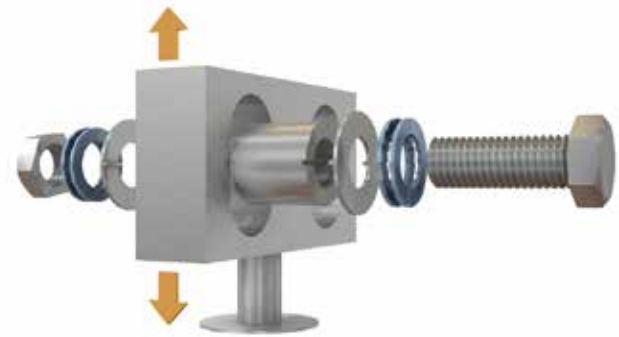

Fig 2: Drawing of the test rig. The assembled parts are vibrated vertically and the joints are subjected to two impacts per cycle. The impacts are parallel to the bolt. The arrow displays the direction of vibration during the test. After testing, the fasteners are inspected for rotation.

Nord-Lock washers are proven as a safe bolt securing system according to NASM 1312-7 tests performed by the independent organization Det Norske Veritas (DNV). If you wish to perform your own real-life testing and evaluation of Nord-Lock washers for your application, you can order samples through [www.nord-lock.com/contact](http://www.nord-lock.com/contact)

### Proven and certified by TÜV

Nord-Lock washers have been certified for safety and quality by TÜV, a leading international institute in quality and safety certification. In a two-step process, TÜV monitored and successfully approved both Nord-Lock washers and Nord-Lock's production facilities.



# Widely used & globally approved



Nord-Lock washers are high end products with documented success in many industries. Our washers are approved by several industry standards and specified by numerous international companies.

## Industries where Nord-Lock washers are used

Nord-Lock washers are used in industries such as: energy, transportation, offshore, mining and quarrying, construction and bridge building, manufacturing and processing, ship building, forestry and agriculture, heavy vehicles, and military. The number of industries that use Nord-Lock washers is continuously growing.

Often joints do not start to loosen until an application is in regular use, therefore Nord-Lock washers are commonly retrofitted during maintenance, repair and overhaul procedures.

## Certificates & approvals

The most prominent of our certificates are:

- AbP (Allgemein bauaufsichtliches Prüfzeugnis)
- DIBt (Deutsches Institut für Bautechnik)
- DNV (Det Norske Veritas)
- EBA (Eisenbahn-Bundesamt)
- TÜV (Technischer Überwachungs-Verein)



## Quality & environmental assurance

- ISO 9001
- ISO 14001
- Licensed by Dörken to perform Delta Protekt® surface coating in-house
- RoHs, ELV and Reach compliant
- Full traceability

For more information or a complete list of certificates and approvals, please visit our website or contact your nearest Nord-Lock representative.

## Traceability

Nord-Lock washers are rigorously tested in all steps of production to verify that the quality requirements are met. Each batch is assigned a control number which ensures full traceability and confirms that the washer is a genuine Nord-Lock article. The control number is printed on the package as well as on every washer pair, enabling full traceability down to first assembly – even when using bin systems for fastener supply.



*In 2011 we began to laser mark our products with the Nord-Lock brand name, the control number and a type code for increased traceability and to facilitate authentication.*

## Laser marking, type code table

Washer type	Code
Steel washers, Delta Protekt® coating	fZn
Stainless steel washers	SS
254 SMO®	254
INCONEL® / HASTELLOY® C-276	276
INCONEL® 718	718

# The key to efficient & secure operations

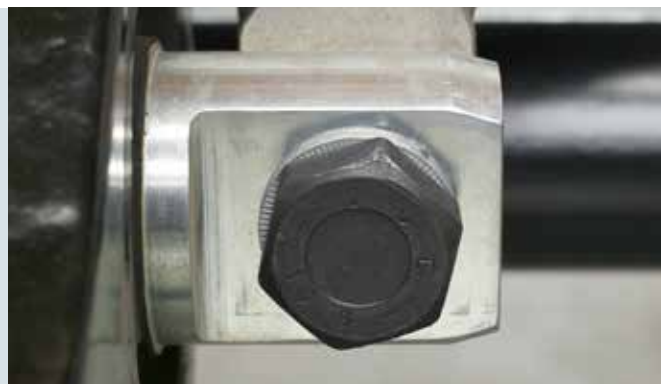

Nord-Lock washers provide more than just a safe locking function, using our washers also improves the general performance of a bolted joint.

## Product benefits

- Maintains high clamp load and thereby ensures the function of the joint
- Quick and easy to install and remove with standard tools
- Locking function not affected by lubrication
- Defined and uniform friction conditions which result in a more accurate preload
- Same temperature characteristics as standard bolt / nut
- Reusable – in addition, Nord-Lock washers do not affect the reusability of fasteners
- The washers are hardened and can support and distribute great loads
- Washers with enlarged outer diameter available for flanged bolts / nuts
- High corrosion resistance
- Can be used with fasteners up to grade 12.9 (ASTM A574)
- Reliable locking, even for joints with short clamp length
- Secures fasteners at both high and low preloads
- No retightening needed
- Verifiable locking function
- Elegant solution and problem solving – modern engineering

## More than a physical product

Nord-Lock offers more than just secure bolted joints. When designing an application, it is important to consider the result it will generate throughout the entire lifespan. When using Nord-Lock products you also benefit from our experience and knowledge. We guide you towards the most beneficial and effective bolt design.

## Life Cycle Profitability

Over the operational life cycle, Nord-Lock products give increased operational reliability and lower maintenance costs while significantly reducing the risks of production stops, accidents and warranty claims. We help you examine all cost factors related to bolted joints.

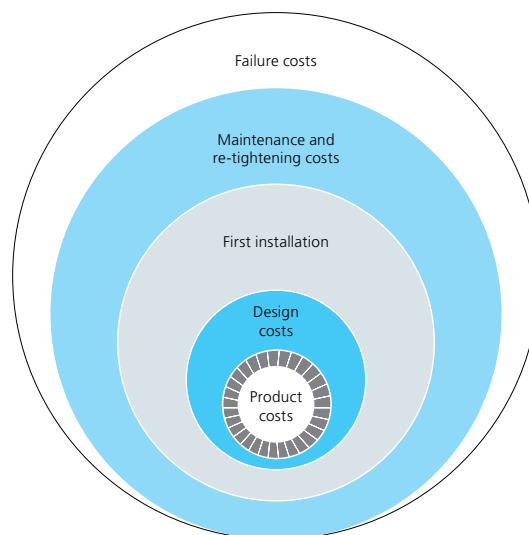

*Nord-Lock products can help you increase your profitability by considering the complete life cycle cost for bolt securing.*

## Technical Center

Our skilled and innovative staff is available to help, review and discuss your applications in order to optimize the design of your bolted connections. Many companies take advantage of the customized tests or joint calculations we offer in our in-house laboratories located in Europe, North America and Asia. In addition, we offer on-site and remote product training.

# Using Nord-Lock washers



Nord-Lock washers are easy and effective to use while ensuring structural security for applications exposed to vibration and dynamic loads.

## Installing the washers

The pre-assembled washers are installed in pairs, cam face to cam face. Nord-Lock recommends lubrication when possible.

## Tightening

Tighten Nord-Lock washers with standard tools according to the guidelines (on page 9-11). Tightening guidelines for other bolt grades are available through your Nord-Lock representative.

## Untightening

Untightening Nord-Lock washers is as simple as tightening. Note that since the locking function is not based on increased friction, the untightening torque is generally lower than the tightening torque. Therefore it is not possible to measure off-torque as verification of locking function.

## Reusing Nord-Lock

Nord-Lock washers can normally be reused. As with all fasteners, they should be inspected for wear before reassembly. Make sure that the washers are reinstalled correctly cam face to cam face. Nord-Lock recommends lubrication of fasteners before reuse in order to minimize changes in friction conditions.



## Possible to verify the locking function

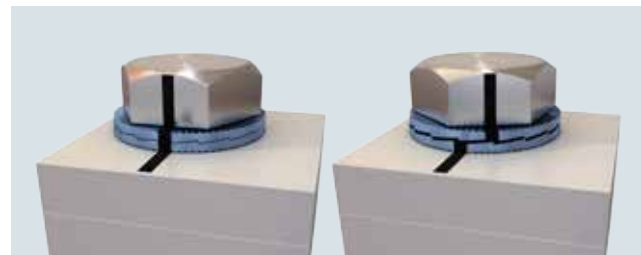

*When untightening a bolt secured by Nord-Lock washers, check that sliding occurs between the cam faces.*



*After disassembly, impression marks must be visible on both the fastener and the contact surface.*

*When the two criteria above are met, you have verified the locking function of the Nord-Lock washers.*

## Utilize the advantages of lubrication

Nord-Lock recommends the use of a high quality, anti-seize lubricant as it improves the tightening results. It is especially beneficial for large sized bolts and stainless steel applications. The Nord-Lock wedge-locking function provides safe locking in both dry and lubricated conditions. Benefits of lubricated fasteners include:

- Improves reusability
- Reduces friction and deviation
- Facilitates assembly and disassembly
- Reduces torsion stress due to minimized thread friction
- Avoids galling and thread seizure
- Additional protection against corrosion



## Nord-Lock washer material / type guide

Application parameter	Steel washers	Stainless steel (ss) washers	254 SMO® washers	INCONEL®/ HASTELLOY® C-276 washers	INCONEL® 718 washers
<b>Steel type</b>	EN 1.7182 or equivalent	EN 1.4404 or equivalent	EN 1.4547 or equivalent	EN 2.4819 or equivalent	EN 2.4667 or equivalent
<b>Examples of applications</b>	General steel applications	General stainless steel applications. Non chlorine / acid environments	General salt water applications, pumps, chloride applications, heat exchangers, nuclear, desalination, food processing & medical equipment	General acidic environments, process and chemical industry, evaporators, offshore downhole tooling	Applications with high temperatures, gas turbines, turbochargers, incinerators
<b>Available for bolt sizes</b>	#5 to 5" (see page 8 for dimensions)	#5 to 3 1/8" (see page 10 for dimensions)	#5 to 1 1/2" (see page 11 for dimensions)	#5 to 1 1/2" available upon request	#5 to 1 1/2" available upon request
<b>Washer types</b>	Regular outer diameter (NL3-NL130) Enlarged outer diameter (NL3.5sp-NL36sp)	Regular outer diameter (NL3ss-NL80ss) Enlarged outer diameter (NL3.5spss-NL30spss)	Regular outer diameter (NL3ss-254-NL39ss-254) Enlarged outer diameter (NL3.5spss-254-NL27spss-254)	Regular outer diameter (NL3ss-276-NL39ss-276) Enlarged outer diameter (NL3.5spss-276-NL27spss-276)	Regular outer diameter (NL3ss-718-NL39ss-718) Enlarged outer diameter (NL3.5spss-718-NL27spss-718)
<b>Treatment</b>	Through hardened	Surface hardened	Surface hardened	Surface hardened	Surface hardened
<b>Surface coating</b>	Delta Protekt® base coat (KL100) and top coat (VH302GZ)				
<b>Washer hardness*</b>	≥ 465 HV1	≥ 520HV0.05	≥ 600HV0.05	≥ 520HV0.05	≥ 620HV0.05
<b>Corrosion resistance</b>	Minimum 600 hours in salt spray test (according to ISO9227)	PREN 27**	PREN 45**	PREN 68**	PREN 29**
<b>Bolt grades</b>	Up to ASTM A574	Up to ASTM F593	Up to ASTM F593	Up to ASTM F593	Up to ASTM F593
<b>Temperature range***</b>	-4F to 392°F	-256°F to 932°F	-256°F to 932°F	-256°F to 932°F	-256°F to 1,292°F

\* In order to assure the unique mechanical locking function of the Nord-Lock washers, the hardness of the mating surfaces must be lower than the hardness of the Nord-Lock washers (see table above).

\*\* PREN (Pitting Resistance Equivalent Number) = %Cr + 3.3x%Mo + 16x%N. Figures in table valid for base material.

\*\*\* Temperature recommendations based on information from the raw material supplier. Locking function not affected within the specification.

# Nord-Lock steel washers

EN 1.7182 or equivalent, zinc flake coating (Delta Protokt®), through hardened

## Dimension chart

Washer size	Bolt size		$\phi_i$ [inch]	$\phi_o$ [inch]	Thickness T [inch]	Min. package [pairs]	Approx. weight lbs / 100 pairs
	UNC	Metric					
NL3	#5	M3	0.13	0.28	0.07	200	0.07
NL3.5	#6	M3.5	0.15	0.30	0.07	200	0.09
NL3.5sp	#6	M3.5	0.15	0.35	0.07	200	0.13
NL4	#8	M4	0.17	0.30	0.07	200	0.09
NL4sp	#8	M4	0.17	0.35	0.07	200	0.13
NL5	#10	M5	0.21	0.35	0.07	200	0.11
NL5sp	#10	M5	0.21	0.43	0.07	200	0.24
NL6		M6	0.26	0.43	0.07	200	0.15
NL6sp		M6	0.26	0.53	0.10	200	0.44
NL1/4"	1/4"		0.28	0.45	0.07	200	0.18
NL1/4"sp	1/4"		0.28	0.53	0.10	200	0.40
NL8	5/16"	M8	0.34	0.53	0.10	200	0.33
NL8sp	5/16"	M8	0.34	0.65	0.10	200	0.62
NL3/8"	3/8"		0.41	0.65	0.10	200	0.51
NL3/8"sp	3/8"		0.41	0.83	0.10	200	1.06
NL10		M10	0.42	0.65	0.10	200	0.49
NL10sp		M10	0.42	0.83	0.10	200	1.04
NL11	7/16"	M11	0.45	0.73	0.10	200	0.64
NL12		M12	0.51	0.77	0.10	200	0.64
NL12sp		M12	0.51	1.00	0.13	100	2.05
NL1/2"	1/2"		0.53	0.77	0.10	200	0.60
NL1/2"sp	1/2"		0.53	1.00	0.13	100	1.98
NL14	9/16"	M14	0.60	0.91	0.13	100	1.23
NL14sp	9/16"	M14	0.60	1.21	0.13	100	3.11
NL16	5/8"	M16	0.67	1.00	0.13	100	1.48
NL16sp	5/8"	M16	0.67	1.21	0.13	100	2.82
NL18		M18	0.77	1.14	0.13	100	1.87
NL18sp		M18	0.77	1.36	0.13	100	3.48
NL3/4"	3/4"		0.79	1.21	0.13	100	2.31
NL3/4"sp	3/4"		0.79	1.54	0.13	100	4.85
NL20		M20	0.84	1.21	0.13	100	2.05
NL20sp		M20	0.84	1.54	0.13	100	4.48
NL22	7/8"	M22	0.92	1.36	0.13	100	2.84
NL22sp	7/8"	M22	0.92	1.65	0.18	50	7.30
NL24		M24	1.00	1.54	0.13	100	3.70
NL24sp		M24	1.00	1.91	0.18	50	9.94
NL1"	1"		1.10	1.54	0.13	100	3.37
NL1"sp	1"		1.10	1.91	0.18	50	9.26
NL27		M27	1.12	1.65	0.23	50	7.25
NL27sp		M27	1.12	1.91	0.23	25	11.88
NL30	1 1/8"	M30	1.24	1.85	0.23	50	9.26
NL30sp	1 1/8"	M30	1.24	2.30	0.26	25	19.75
NL33	1 1/4"	M33	1.35	1.91	0.23	25	8.75
NL33sp	1 1/4"	M33	1.35	2.30	0.26	25	18.32
NL36	1 3/8"	M36	1.47	2.17	0.23	25	12.32
NL36sp	1 3/8"	M36	1.47	2.48	0.26	25	20.17
NL39	1 1/2"	M39	1.59	2.30	0.23	25	13.85
NL42		M42	1.70	2.48	0.23	25	16.47
NL45	1 3/4"	M45	1.82	2.76	0.28	25	22.49
NL48		M48	1.95	2.95	0.28	25	26.46
NL52	2"	M52	2.11	3.15	0.28	25	28.66
NL56	2 1/4"	M56	2.33	3.35	0.28	10	29.76
NL60		M60	2.48	3.54	0.28	10	33.51
NL64	2 1/2"	M64	2.64	3.74	0.28	10	36.82
NL68		M68	2.80	3.94	0.37	1	62.15
NL72		M72	2.96	4.13	0.37	1	67.68
NL76	3"	M76	3.11	4.33	0.37	1	73.43
NL80	3 1/8"	M80	3.27	4.53	0.37	1	79.41
NL85		M85	3.47	4.72	0.37	1	83.42
NL90		M90	3.64	5.12	0.37	1	105.09
NL95		M95	3.83	5.31	0.37	1	109.81
NL100	4"	M100	4.07	5.71	0.37	1	129.87
NL105		M105	4.27	5.91	0.37	1	135.10
NL110		M110	4.46	6.10	0.37	1	140.32
NL115		M115	4.66	6.50	0.37	1	165.96
NL120		M120	4.86	6.69	0.37	1	171.83
NL125		M125	5.06	6.81	0.37	1	168.94
NL130	5"	M130	5.25	7.01	0.37	1	174.54

NL3–NL8  
 $\phi_i \pm 0.004$  inch  
 NL10–NL42  
 $\phi_i \pm 0.008$  inch  
 NL45–NL130  
 $\phi_i +0.02/-0$  inch

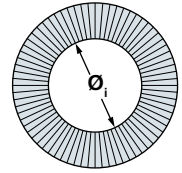

NL3–NL24 (NL1")  
 $\phi_o \pm 0.008$  inch  
 NL27–NL42  
 $\phi_o \pm 0.012$  inch  
 NL45–NL130  
 $\phi_o +0/-0.08$  inch

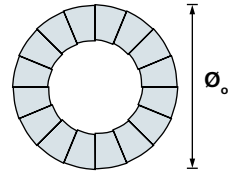

NL3–NL42  
 $T \pm 0.01$  inch  
 NL45–NL130  
 $T \pm 0.03$  inch

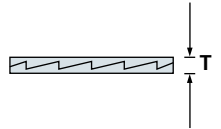

Note that washers with thickness 0.26 inch has a thickness tolerance  $+0.0 / -0.02$  inch

- Please consult our website for current dimensions and 2D / 3D CAD models:  
[www.nord-lock.com/cad](http://www.nord-lock.com/cad).

Nord-Lock washers made of steel with zinc flake coating are standard stock items, yet subject to prior sale.



# Torque guidelines

Nord-Lock steel washers with zinc flake coating (Delta Protekt®)

Nord-Lock steel washers with electro zinc plated **bolt (grade 5)**

Washer size	Bolt size	Pitch [TPI]	Oil, $G_f=75\%$ $\mu_{th}=0,10, \mu_b=0,16$		Cu/C paste, $G_f=75\%$ $\mu_{th}=0,11, \mu_b=0,16$		Dry, $G_f=62\%$ $\mu_{th}=0,15, \mu_b=0,18$	
			Torque [ftlb]	Clamp load [lb]	Torque [ftlb]	Clamp load [lb]	Torque [ftlb]	Clamp load [lb]
NL3	#5	40	1.1	550	1.0	550	1.1	450
NL3.5	#6	32	1.4	630	1.3	630	1.5	520
NL4	#8	32	2.7	970	2.3	970	2.6	800
NL5	#10	24	3.9	1,200	3.5	1200	4.0	1,000
NL1/4"	1/4	20	9.1	2,200	8.2	2200	9.0	1,800
NL8	5/16	18	18	3,600	16	3600	18	3,000
NL3/8"	3/8	16	30	5,400	27	5400	31	4,400
NL11	7/16	14	47	7,300	42	7300	47	6,100
NL1/2"	1/2	13	73	9,800	66	9800	74	8,100
NL14	9/16	12	104	12,600	93	12600	104	10,400
NL16	5/8	11	145	15,600	130	15600	146	12,900
NL3/4"	3/4	10	254	23,100	227	23100	257	19,100
NL22	7/8	9	408	31,900	367	31900	413	26,400
NL1"	1	8	617	41,800	556	41800	624	34,600
NL30	1 1/8	7	771	46,400	695	46400	780	38,400
NL33	1 1/4	7	1075	58,900	965	58900	1090	48,700
NL36	1 3/8	6	1410	70,200	1270	70200	1430	58,100
NL39	1 1/2	6	1860	85,500	1670	85500	1880	70,600

Cu/C paste = Copper/graphite paste (Molykote® 1000)

$G_f$  = ratio of yield point

$\mu_{th}$  = thread friction

$\mu_b$  = washer friction

1 lbf = 4.448 N

1 ft-lb = 1.356 Nm

Nord-Lock steel washers with non-plated **bolt (grade 8)**

Washer size	Bolt size	Pitch [TPI]	Oil, $G_f=71\%$ $\mu_{th}=0,13, \mu_b=0,14$		Cu/C paste, $G_f=75\%$ $\mu_{th}=0,11, \mu_b=0,15$	
			Torque [ftlb]	Clamp load [lb]	Torque [ftlb]	Clamp load [lb]
NL3	#5	40	1.5	740	1.3	780
NL3.5	#6	32	1.9	840	1.6	890
NL4	#8	32	3.5	1,300	3	1,400
NL5	#10	24	5.1	1,600	4.4	1,700
NL1/4"	1/4	20	12	2,900	11	3,100
NL8	5/16	18	24	4,900	20	5,100
NL3/8"	3/8	16	41	7,200	35	7,600
NL11	7/16	14	64	9,800	54	10,400
NL1/2"	1/2	13	99	13,100	83	13,900
NL14	9/16	12	138	16,800	119	17,800
NL16	5/8	11	197	20,900	166	22,100
NL3/4"	3/4	10	346	30,900	291	32,700
NL22	7/8	9	556	42,700	472	45,100
NL1"	1	8	840	56,000	713	59,200
NL30	1 1/8	7	1190	70,600	1015	74,500
NL33	1 1/4	7	1660	89,600	1409	94,600
NL36	1 3/8	6	2180	107,000	1852	113,000
NL39	1 1/2	6	2870	130,000	2433	137,000

Nord-Lock steel washers with non-plated **ASTM A574 bolt, (high-grade)**

Washer size	Bolt size	Pitch [TPI]	Oil, $G_f=71\%$ $\mu_{th}=0,13, \mu_b=0,12$		Cu/C paste, $G_f=75\%$ $\mu_{th}=0,11, \mu_b=0,15$	
			Torque [ftlb]	Clamp load [lb]	Torque [ftlb]	Clamp load [lb]
NL3	#5	40	1.7	870	1.5	910
NL3.5	#6	32	2.2	990	1.9	1050
NL4	#8	32	3.8	1,500	3.6	1600
NL5	#10	24	5.8	1,900	5.3	2000
NL1/4"	1/4	20	13	3,400	12	3700
NL8	5/16	18	26	5,700	22	6000
NL3/8"	3/8	16	45	8,400	38	8900
NL11	7/16	14	70	11,500	58	12,200
NL1/2"	1/2	13	109	15,400	90	16,300
NL14	9/16	12	148	19,800	137	20,900
NL16	5/8	11	216	24,600	179	26,000
NL3/4"	3/4	10	378	36,400	312	38,400
NL22	7/8	9	607	50,200	506	53,000
NL1"	1	8	916	65,900	764	69,600
NL30	1 1/8	7	1300	83,000	1084	87,700
NL33	1 1/4	7	1810	105,000	1507	111,000
NL36	1 3/8	6	2380	126,000	1990	133,000
NL39	1 1/2	6	3140	153,000	2600	161,000

Torque guidelines for other bolt grades are available through your local Nord-Lock representative.

# Nord-Lock stainless steel washers

EN 1.4404 (AISI 316L) or equivalent, surface hardened

EN 1.4404 is an austenitic chromium-nickel stainless steel containing molybdenum. This stainless steel also has extra low carbon content in order to reduce the risk of chromium-carbide precipitation. EN 1.4404 is one of the most commonly used stainless steel grades and Nord-Lock washers made of EN 1.4404 are suitable for most applications where no chlorides or acids are present.

## Dimension chart

Washer size	Bolt size		$\phi$ [inch]	$\phi_i$ [inch]	Thickness T [inch]	Min. package [pairs]	Approx. weight lbs / 100 pairs
	UNC	Metric					
NL3ss	#5	M3	0.13	0.28	0.09	200	0.09
NL3.5ss	#6	M3.5	0.15	0.30	0.09	200	0.09
NL3.5spss	#6	M3.5	0.15	0.35	0.09	200	0.15
NL4ss	#8	M4	0.17	0.30	0.09	200	0.09
NL4spss	#8	M4	0.17	0.35	0.09	200	0.15
NL5ss	#10	M5	0.21	0.35	0.09	200	0.13
NL5spss	#10	M5	0.21	0.43	0.09	200	0.24
NL6ss		M6	0.26	0.43	0.09	200	0.20
NL6spss		M6	0.26	0.53	0.08	200	0.35
NL1/4"ss	1/4"		0.28	0.45	0.09	200	0.20
NL1/4"spss	1/4"		0.28	0.53	0.09	200	0.33
NL8ss	5/16"	M8	0.34	0.53	0.08	200	0.26
NL8spss	5/16"	M8	0.34	0.65	0.08	200	0.48
NL3/8"ss	3/8"		0.41	0.65	0.08	200	0.42
NL3/8"spss	3/8"		0.41	0.83	0.08	200	0.84
NL10ss		M10	0.42	0.65	0.08	200	0.40
NL10spss		M10	0.42	0.83	0.08	200	0.82
NL11ss	7/16"	M11	0.45	0.73	0.09	200	0.57
NL12ss		M12	0.51	0.77	0.08	200	0.51
NL12spss		M12	0.51	1.00	0.12	100	1.81
NL1/2"ss	1/2"		0.53	0.77	0.08	200	0.53
NL1/2"spss	1/2"		0.53	1.00	0.13	100	1.76
NL14ss	9/16"	M14	0.60	0.91	0.12	100	1.08
NL14spss	9/16"	M14	0.60	1.21	0.13	100	2.89
NL16ss	5/8"	M16	0.67	1.00	0.12	100	1.30
NL16spss	5/8"	M16	0.67	1.21	0.13	100	2.49
NL18ss		M18	0.77	1.14	0.13	100	1.76
NL18spss		M18	0.77	1.36	0.13	100	3.44
NL3/4"ss	3/4"		0.79	1.21	0.13	100	2.12
NL3/4"spss	3/4"		0.79	1.54	0.13	100	4.63
NL20ss		M20	0.84	1.21	0.12	100	1.81
NL20spss		M20	0.84	1.54	0.13	100	4.54
NL22ss	7/8"	M22	0.92	1.36	0.13	100	2.71
NL22spss	7/8"	M22	0.92	1.65	0.13	50	4.92
NL24ss		M24	1.00	1.54	0.13	100	3.35
NL24spss		M24	1.00	1.91	0.13	50	7.72
NL1"ss	1"		1.10	1.54	0.13	100	3.13
NL1"spss	1"		1.10	1.91	0.13	50	7.10
NL27ss		M27	1.12	1.65	0.27	50	7.61
NL27spss		M27	1.12	1.91	0.27	25	12.90
NL30ss	1 1/8"	M30	1.24	1.85	0.27	50	9.77
NL30spss	1 1/8"	M30	1.24	2.30	0.27	25	21.01
NL33ss	1 1/4"	M33	1.35	1.91	0.27	25	9.37
NL36ss	1 3/8"	M36	1.47	2.17	0.27	25	13.14
NL39ss	1 1/2"	M39	1.59	2.30	0.27	25	14.86
NL42ss		M42	1.70	2.48	0.27	25	17.55
NL45ss	1 3/4"	M45	1.82	2.76	0.27	25	22.49
NL48ss		M48	1.95	2.95	0.27	25	26.46
NL52ss	2"	M52	2.11	3.15	0.35	1	44.31
NL56ss	2 1/4"	M56	2.33	3.35	0.35	1	46.96
NL60ss		M60	2.48	3.54	0.35	1	51.81
NL64ss	2 1/2"	M64	2.64	3.74	0.35	1	56.88
NL68ss		M68	2.80	3.94	0.35	1	62.17
NL72ss		M72	2.96	4.13	0.35	1	67.68
NL76ss	3"	M76	3.11	4.33	0.35	1	73.41
NL80ss	3 1/8"	M80	3.27	4.53	0.35	1	79.37

NL3ss – NL8ss  
 $\phi_i \pm 0.004$  inch  
 NL10ss – NL42ss  
 $\phi_i \pm 0.008$  inch  
 NL45ss – NL80ss  
 $\phi_i +0.02/-0$  inch

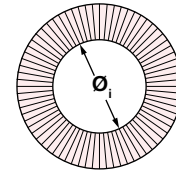

NL3ss – NL24ss (NL1"ss)  
 $\phi_o \pm 0.008$  inch  
 NL27ss – NL42ss  
 $\phi_o \pm 0.012$  inch  
 NL45ss – NL80ss  
 $\phi_o +0/-0.08$  inch

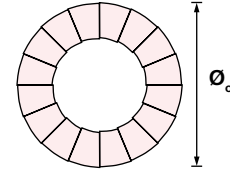

NL3ss – NL24ss (NL1"ss)  
 $T \pm 0.01$  inch  
 NL27ss – NL42ss  
 $T +0/-0.02$  inch  
 NL45ss – NL80ss  
 $T \pm 0.03$  inch

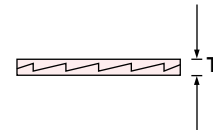

- Please consult our website for current dimensions and 2D / 3D CAD models: [www.nord-lock.com/cad](http://www.nord-lock.com/cad).

## Torque guidelines

Nord-Lock stainless steel washers with **ASTM F593 bolt**, lubricated with copper/graphite paste (Molykote® 1000).

Washer size	Bolt size	Pitch [TPI]	316-316L, $G_f=65\%$ $\mu_{th}=0.12, \mu_w=0.14$		303-305, $G_f=65\%$ $\mu_{th}=0.12, \mu_w=0.14$	
			Torque [ftlb]	Clamp load [lb]	Torque [ftlb]	Clamp load [lb]
NL3ss	#5	40	0.7	325	0.7	325
NL3.5ss	#6	32	0.9	370	0.9	370
NL4ss	#8	32	1.4	575	1.4	575
NL5ss	#10	24	2.2	720	2.2	720
NL1/4"ss	1/4	20	5	1,300	5	1,300
NL8ss	5/16	18	9.9	2,200	9.9	2,200
NL3/8"ss	3/8	16	17	3,300	17	3,300
NL11ss	7/16	14	22	4,500	22	4,500
NL1/2"ss	1/2	13	41	6,000	41	6,000
NL14ss	9/16	12	59	7,700	59	7,700
NL16ss	5/8	11	83	9,500	83	9,500
NL3/4"ss	3/4	10	101	9,800	101	9,800
NL22ss	7/8	9	164	13,500	164	13,500
NL1"ss	1	8	247	17,700	247	17,700
NL30ss	1 1/8	7	351	22,300	351	22,300
NL36ss	1 3/8	6	643	33,800	643	33,800

Cu/C paste = Copper/graphite paste (Molykote® 1000),  
 $G_f$  = ratio of yield point,  $\mu_{th}$  = thread friction,  $\mu_w$  = washer friction

1 lbf = 4.448 N  
 1 ft-lb = 1.356 Nm

Torque guidelines for other bolt grades are available through your local Nord-Lock representative.

Nord-Lock washers made of stainless steel are standard stock items, yet subject to prior sale.

# Nord-Lock 254 SMO® washers

EN 1.4547 or equivalent, surface hardened

254 SMO® is a high performance austenitic stainless steel (according to EN 1.4547) with greater mechanical strength and resistance against corrosion than most austenitic stainless steel grades. The material is resilient against pitting and crevice corrosion due to high contents of chromium, nickel, molybdenum and nitrogen. Nord-Lock 254 SMO® washers are specially designed for chloride rich processes and salt water solutions / atmospheres, i.e. environments where stainless steel washers made of EN 1.4404 are not suitable.

## Dimension chart

Washer size	Bolt size		$\phi_i$ [inch]	$\phi_o$ [inch]	Thickness T [inch]	Min. package [pairs]	Approx weight lbs / 100 pairs
	UNC	Metric					
NL3ss-254	#5	M3	0.13	0.28	0.09	200	0.09
NL3.5ss-254	#6	M3.5	0.15	0.30	0.09	200	0.09
NL3.5spss-254	#6	M3.5	0.15	0.35	0.09	200	0.15
NL4ss-254	#8	M4	0.17	0.30	0.09	200	0.09
NL4spss-254	#8	M4	0.17	0.35	0.09	200	0.15
NL5ss-254	#10	M5	0.21	0.35	0.09	200	0.13
NL5spss-254	#10	M5	0.21	0.43	0.09	200	0.24
NL6ss-254		M6	0.26	0.43	0.09	200	0.20
NL6spss-254		M6	0.26	0.53	0.09	200	0.35
NL1/4"ss-254	1/4"		0.28	0.45	0.09	200	0.20
NL1/4"spss-254	1/4"		0.28	0.53	0.09	200	0.33
NL8ss-254	5/16"	M8	0.34	0.53	0.08	200	0.26
NL8spss-254	5/16"	M8	0.34	0.65	0.09	200	0.48
NL3/8"ss-254	3/8"		0.41	0.65	0.08	200	0.42
NL3/8"spss-254	3/8"		0.41	0.83	0.09	200	0.84
NL10ss-254		M10	0.42	0.65	0.08	200	0.40
NL10spss-254		M10	0.42	0.83	0.09	200	0.82
NL11ss-254	7/16"	M11	0.45	0.73	0.09	200	0.57
NL12ss-254		M12	0.51	0.77	0.08	200	0.51
NL12spss-254		M12	0.51	1.00	0.12	100	1.81
NL1/2"ss-254	1/2"		0.53	0.77	0.09	200	0.53
NL1/2"spss-254	1/2"		0.53	1.00	0.13	100	1.76
NL14ss-254	9/16"	M14	0.60	0.91	0.12	100	1.08
NL14spss-254	9/16"	M14	0.60	1.21	0.13	100	2.89
NL16ss-254	5/8"	M16	0.67	1.00	0.12	100	1.30
NL16spss-254	5/8"	M16	0.67	1.21	0.13	100	2.49
NL18ss-254		M18	0.77	1.14	0.13	100	1.76
NL18spss-254		M18	0.77	1.36	0.13	100	3.44
NL3/4"ss-254	3/4"		0.79	1.21	0.13	100	2.12
NL3/4"spss-254	3/4"		0.79	1.54	0.13	100	4.72
NL20ss-254		M20	0.84	1.21	0.12	100	1.81
NL20spss-254		M20	0.84	1.54	0.13	100	4.36
NL22ss-254	7/8"	M22	0.92	1.36	0.13	100	2.62
NL22spss-254	7/8"	M22	0.92	1.65	0.13	50	5.34
NL24ss-254		M24	1.00	1.54	0.13	100	3.64
NL24spss-254		M24	1.00	1.91	0.13	50	7.72
NL1"ss-254	1"		1.10	1.54	0.13	100	3.13
NL1"spss-254	1"		1.10	1.91	0.22	50	7.10
NL27ss-254		M27	1.12	1.65	0.22	50	6.83
NL27spss-254		M27	1.12	1.91	0.22	25	12.90
NL30ss-254	1 1/8"	M30	1.24	1.85	0.22	50	8.90
NL33ss-254	1 1/4"	M33	1.35	1.91	0.22	25	9.37
NL36ss-254	1 3/8"	M36	1.47	2.17	0.22	25	13.14
NL39ss-254	1 1/2"	M39	1.59	2.30	0.22	25	14.86

Nord-Lock washers made of 254 SMO® quality are standard stock items, yet subject to prior sale.

NL3ss-254–NL8ss-254

$\phi_i \pm 0.004$  inch

NL10ss-254–NL39ss-254

$\phi_i \pm 0.008$  inch

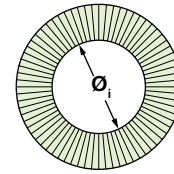

NL3ss-254 –NL24ss-254

(NL1"ss-254)

$\phi_o \pm 0.008$  inch

NL27ss-254–NL39ss-254

$\phi_o \pm 0.012$  inch

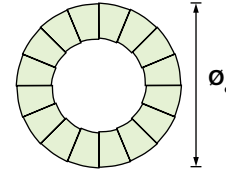

NL3ss-254 –NL39ss-254

T  $\pm 0.01$  inch

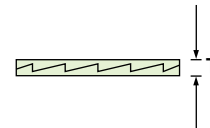

- Please consult our website for current dimensions and 2D / 3D CAD models: [www.nord-lock.com/cad](http://www.nord-lock.com/cad).

## Torque guidelines

Nord-Lock 254 SMO® washers with **ASTM F593 bolt**, lubricated with copper/graphite paste (Molykote® 1000).

Washer size	Bolt size	Pitch [TPI]	316-316L, G <sub>r</sub> =65% $\mu_{th}=0,12, \mu_b=0,14$		303-305, G <sub>r</sub> =65% $\mu_{th}=0,12, \mu_b=0,14$	
			Torque [ftlb]	Clamp load [lb]	Torque [ftlb]	Clamp load [lb]
NL3ss-254	#5	40	0.7	325	0.7	325
NL3.5ss-254	#6	32	0.9	370	0.9	370
NL4ss-254	#8	32	1.4	575	1.4	575
NL5ss-254	#10	24	2.2	720	2.2	720
NL1/4"ss-254	1/4"	20	5	1,300	5	1,300
NL8ss-254	5/16"	18	9.9	2,200	9.9	2,200
NL3/8"ss-254	3/8"	16	17	3,300	17	3,300
NL11ss-254	7/16"	14	22	4,500	22	4,500
NL1/2"ss-254	1/2"	13	41	6,000	41	6,000
NL14ss-254	9/16"	12	59	7,700	59	7,700
NL16ss-254	5/8"	11	83	9,500	83	9,500
NL3/4"ss-254	3/4"	10	101	9,800	101	9,800
NL22ss-254	7/8"	9	164	13,500	164	13,500
NL1"ss-254	1"	8	247	17,700	247	17,700
NL30ss-254	1 1/8"	7	351	22,300	351	22,300
NL36ss-254	1 3/8"	6	643	33,800	643	33,800

Cu/C paste = Copper/graphite paste (Molykote® 1000),  
G<sub>r</sub>= ratio of yield point,  $\mu_{th}$  = thread friction,  $\mu_b$  = washer friction

1 lbf = 4.448 N

1 ft-lb = 1.356 Nm

Torque guidelines for other bolt grades are available through your local Nord-Lock representative.

# Nord-Lock washers joint guide



## Tapped holes

Nord-Lock washers safely lock the bolt against the underlying surface.



## Counter bores

The outer diameter of regular Nord-Lock washers is designed for counter-bore holes according to DIN 974, i.e. the washers fit under the head of standard bolts.



## Through holes

As for all locking washers, through holes require two pairs of Nord-Lock washers – one pair for securing the bolt and a second pair for securing the nut.

Turn both fasteners in order to close the cams on both washer pairs before tightening to minimize settlements. Keep the nut secured while tightening the bolt.



## Stud bolts

Nord-Lock washers safely lock the nut on stud bolts and eliminate the need for adhesives.



Large / slotted holes



Soft underlying surfaces

## Applications with large / slotted holes or soft underlying surfaces

To optimize the load distribution for applications with large / slotted holes or with soft underlying surface, use a flanged nut / bolt together with Nord-Lock "sp" washers with enlarged outer diameter.



## Designs where Nord-Lock washers are not recommended

- Mating surfaces that are not locked in place (see left figure)
- Mating surfaces harder than the washers
- Very soft mating surface, e.g. wood, plastic
- Applications with extremely large settlements
- Non-preloaded joints

*If your application corresponds to one or more of the mentioned design criteria, contact your Nord-Lock representative and we will help you find an alternative solution.*

## Nord-Lock "sp" (enlarged outer diameter) washers

Nord-Lock washers are available with an enlarged outer diameter, referred to as "sp" washers. "sp" washers are designed for use on large / slotted holes, painted / sensitive surfaces or soft materials. Use Nord-Lock "sp" washers with flanged bolts or nuts for optimum load distribution.



*A flanged nut and Nord-Lock "sp" washers increase the load supporting surface for applications with slotted holes.*

$\varnothing$  inner regular =  $\varnothing$  inner "sp"  
 $\varnothing$  outer regular <  $\varnothing$  outer "sp"

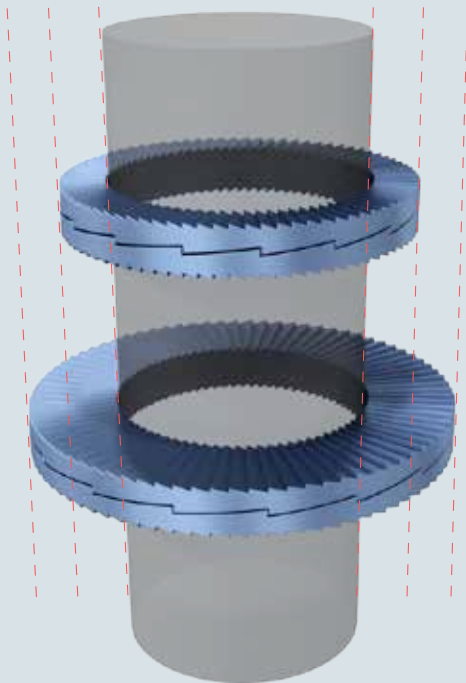

By using "sp" washers, the load is distributed over a larger surface which can be more gentle for sensitive surfaces. Please consult Nord-Lock to find the optimal solution for your application.

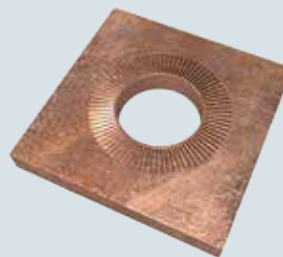

*Nord-Lock "sp" washers on soft metal.*

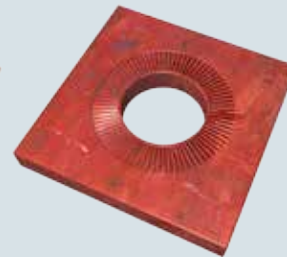

*Nord-Lock "sp" washers on painted surface.*

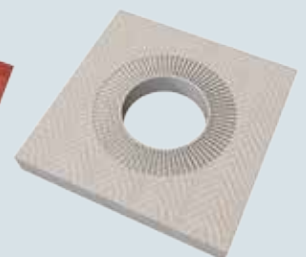

*Nord-Lock "sp" washers on fibre surface.*

## Uniform friction with Nord-Lock washers

It is important to have control over the friction conditions in order to obtain the desired preload when tightening a joint.

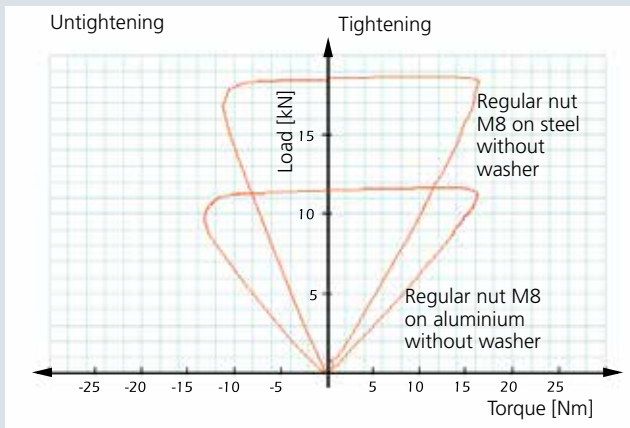

When no washer is used under the fastener, the friction depends on the contact surface. At a given torque, the obtained preload will vary depending on the contact material.

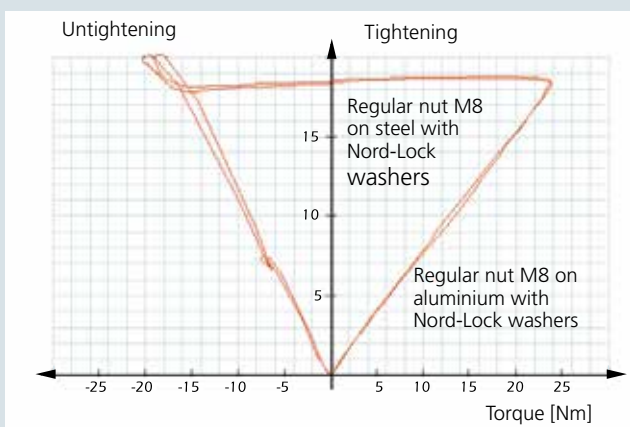

When using Nord-Lock washers, sliding always occurs between the upper washer and the bolt head / nut. At a given torque, the preload will be the same, regardless of the contact material.

Nord-Lock provides customized torque guidelines for your application, contact your nearest representative.

# Your partner in bolt securing



The Nord-Lock Group offers continuous support; from design phase, testing and verification, through installation and maintenance. We continually develop our products and unique solutions by using state-of-the-art bolt securing technology.

We also know that a good product is not enough. At Nord-Lock we share our experience, knowledge and creativity to help our clients achieve the outstanding results they require. Let Nord-Lock be your partner in bolt optimization.

## Customer unique solutions

Over the years, The Nord-Lock Group has entered several partnerships to develop unique solutions for the most creative designs. Should you find that the products presented in this brochure do not meet your requirements – let us help you find the optimum solution.



*The Nord-Lock Group product portfolio includes a wide range of products and we are continuously developing new innovative solutions. Contact us to learn more about our current range.*

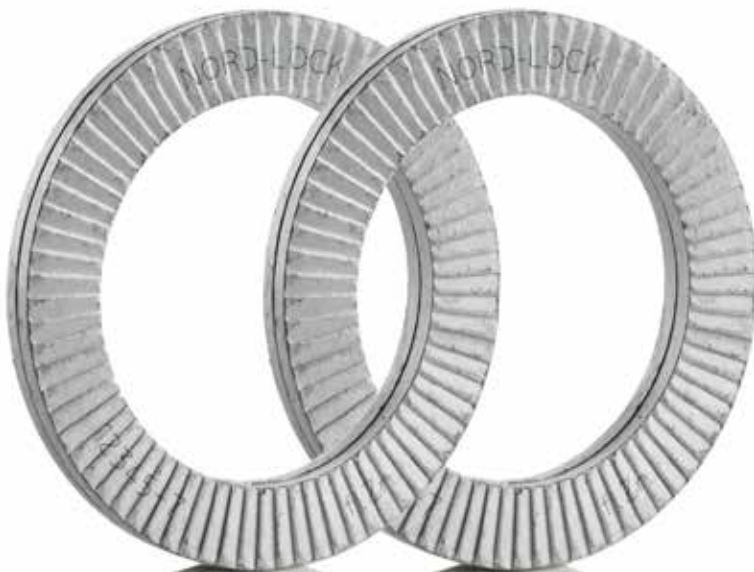



### Performance Services

Nord-Lock Performance Services is a partnership project offered to key customers. The purpose is to increase profitability by generating a complete and detailed view of the design of bolted connections and securing methods. As each project is designed to meet customer specific needs and challenges, both current applications and future designs can be investigated. In addition, our global chain of services supports you throughout sourcing, design / production and aftermarket.

### Presence in your market

The Nord-Lock Group includes subsidiaries, in-house laboratories on three continents, and a worldwide network of authorized distributors. In addition, our Global Industry Managers with specialist skills are trained to understand the specific needs and challenges in your industry. Our philosophy is to be close to our customers, to speak your language and to help you achieve secure and effective bolted joints. To find the complete list of Nord-Lock representatives, please go to [www.nord-lock.com/contact](http://www.nord-lock.com/contact).



### Nord-Lock global chain of services

#### Sourcing

Life Cycle Profitability and cost justification

Cost savings generated by optimized bolted joints.

#### Design / Production

Field Application Engineer, Technical Centers & Project Engineering

Joint calculation and simulation. Real life testing and validation. Custom designs.

#### Aftermarket

On-site and remote product training as well as service and retrofitting

Increasing the knowledge for operators and engineers. Installation support.

# When **safety** really matters



Joining parts together is one of the most critical steps when delivering a product or system. The Nord-Lock Group is focused on solving the toughest bolting challenges. We offer a unique combination of bolting expertise and a wide product range, including wedge-locking technology and Superbolt tensioners — all designed and developed in-house.

Nord-Lock holds decades of documented success in every major industry, including oil and gas, energy, transportation and mining. Our Production System includes rigorous internal testing and full traceability, and our products hold several certificates from independent institutes including AbP, ABS, DIBt, DNV and TÜV.

The tools available through Nord-Lock Performance Services add value throughout a project and ensure that your bolting application pays back multiple times. We can also assist you in the design phase with joint simulation and testing. Additionally, we help you ensure successful operations over time with our on site support and remote product training.

Our mission is to safeguard human lives and customer investments by securing the world's most demanding applications. The Nord-Lock Group looks forward to being your partner in bolting solutions.

Authorized distributor:

© Copyright 2014 Nord-Lock Group. NORD-LOCK and SUPERBOLT are trademarks owned by different companies within the Nord-Lock Group. All other logos, trademarks, registered trademarks or service marks used herein are the property of the Nord-Lock Group. All rights reserved.

**Nord-Lock Inc.**  
1000 Gregg St. • Carnegie, PA 15106, USA  
Phone: 412-279-1149 • Fax: 412-279-1185 • Email: [bolting@nord-lock.com](mailto:bolting@nord-lock.com)  
[www.nord-lock.com](http://www.nord-lock.com)

**NORD-LOCK®**  
Bolt securing systems